

Global Service Network-Overseas Area

IFE Elevators & Escalators (Russia)

Tel: +7(926)-894-81-96 Email: ru@ifelift.com
Address: SK Plaza, Dmitrovskoe Road 163ak2, Moscow, Russia

M/s IFE MIDDLE EAST ELEVATORS LLC

Tel: +971(0)42505888 Email: ae@ifelift.com
Address: 502# Sapphire Tower, Ittihad Road ,Deira Dubai, UAE

IFE Elevators & Escalators (Australia) Pty Ltd

Tel: +61(0)8 9202 4666 Email: au@ifelift.com
Address: 36 Beringarra Avenue Malaga WA 6090

PT.IFE ELEVATORS INDONESIA

Tel: +62 21 22604802 Email: ifeindo@ifelift.com
Address: The Mansion Dukuh Golf Kemayoran Tower Fontana Lt.21 Unit L2 & m2,
JI Trembesi Blok D4 Pademangan Timur Pademangan Jakarta Utara Dki Jakarta 14410

IFE ELEVATORS LANKA

Tel: +94112686867 Email: SI@ifelift.com
Address: 158/9 Lake Drive colombo 08 Sri lanka

Office in Singapore

Tel: +86 13929229955
Address: 23 Genting Road #07-01/02 Chevalier House Singapore 349481



IFE ELEVATORS CO.,LTD

China Factory: Qingxi Town, Dongguan City, Guangdong
Tel: +86-769-82078888 Fax: +86-769-87732448
Hotline: 400-6789-443 Website: www.ife.cn

MOVING & SERVING
The image and content are just for you reference and please be subject to the actual products. Please pardon us for not informing you in advance if anything updated.
Please contact IFE for details.

201901 © All Rights Reserved @ IFE



JOYMORE-7 Machine Roomless Passenger Elevator

Trusted by the World
Stock code: 002774



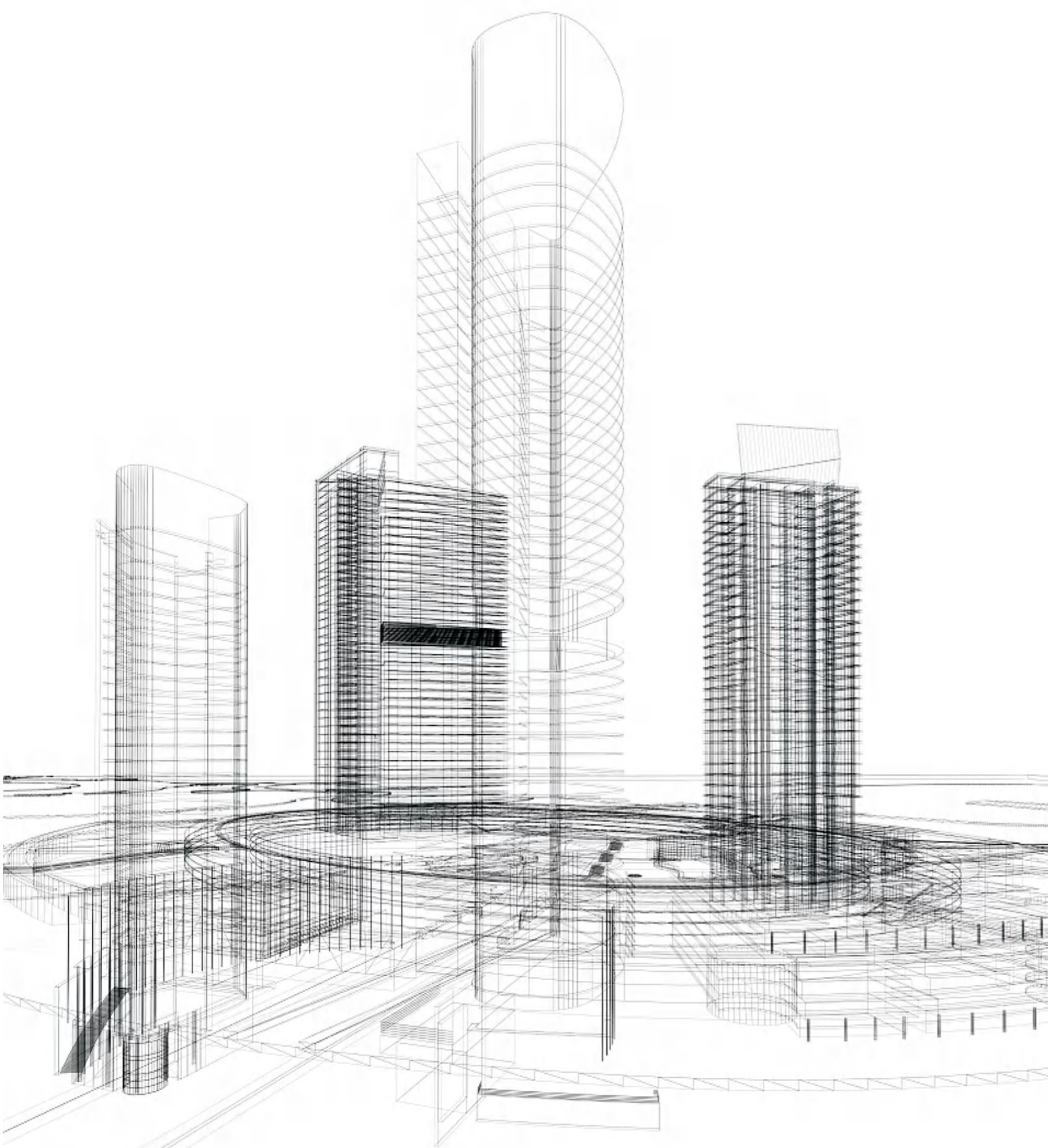

Innovation Pays Tribute to Design

Pay Tribute to Architects for a Better Life

IFE JOYMORE-7 Machine Roomless Passenger Elevator is a leading technology that combines people-oriented design concepts to improve the utilization of the hoistway, reduce the overhead height and pit depth, meanwhile meeting the requirements of safety and comfort, providing flexible building vertical traffic solutions for architectural design.

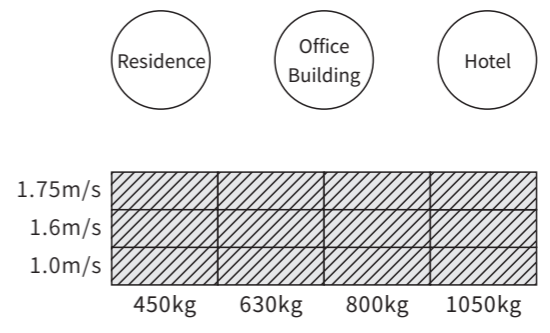

High hoistway utilization, Reduce construction costs

Space Saving, Flexible Layout

The minimum overhead height is 3500mm,
and the smallest pit depth is 1100mm

It meets the minimum overhead height of 3,500 mm and the smallest pit depth of 1,100 mm,
saving construction costs and perfecting the architectural space aesthetics.

3500mm

Minimum overhead height

1120mm

Smallest pit depth

High hoistway utilization and smaller footprint

The JOYMORE-7 hoistway has high utilization rate, greatly improving utilization of building space
and giving more freedom to building design.

Flexible layout reduces construction costs

Flexible layout reduces overhead height and pit depth, making civil construction more flexible,
effectively reducing construction costs, modern architecture wisdom preferred.

Easy installation and improved efficiency

The JOYMORE-7 machine roomless passenger elevator is structurally compact and light, easy to
install and maintain, improves installation efficiency.

Car height: 2.2 meters (1.0m/s)

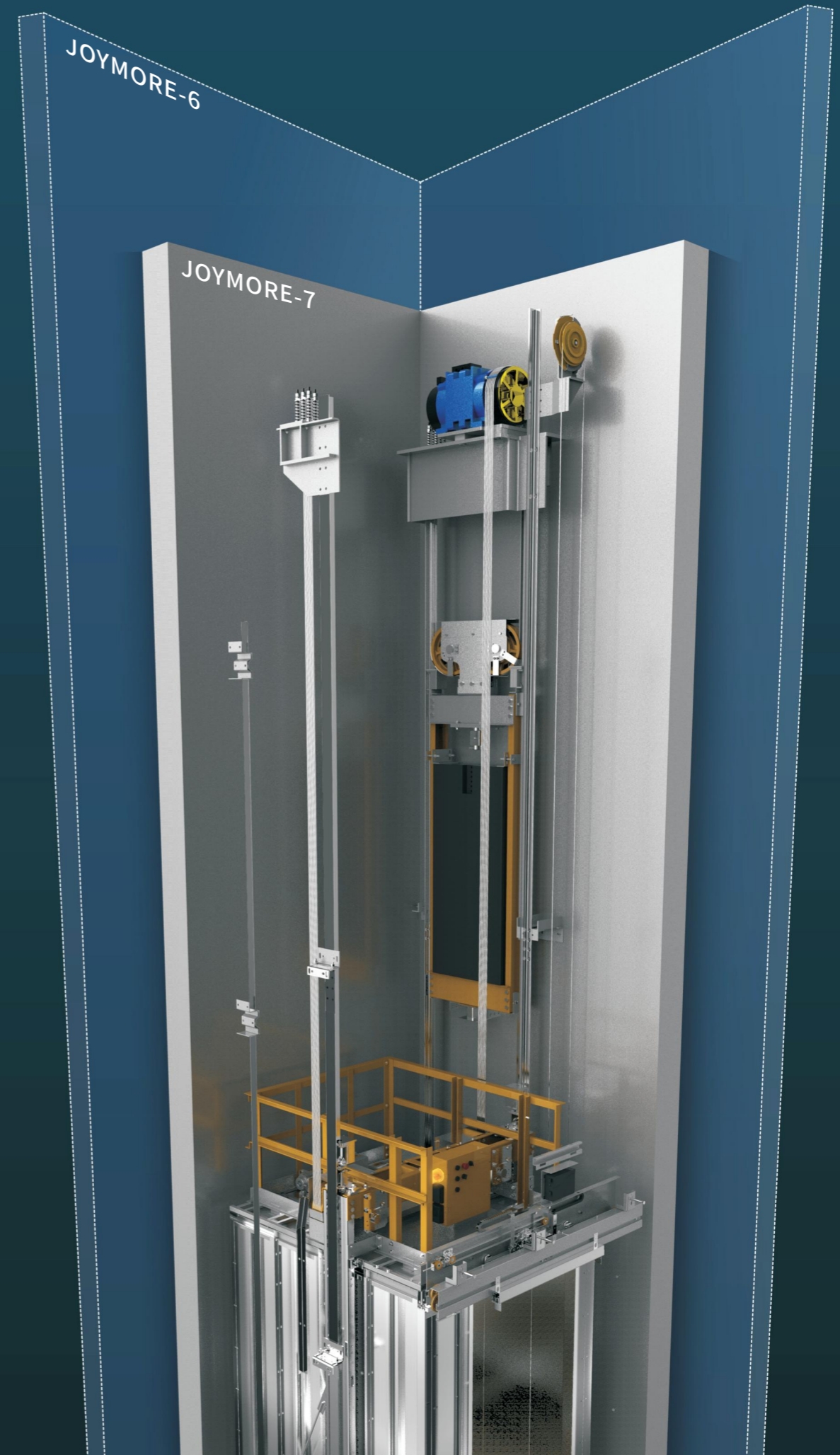
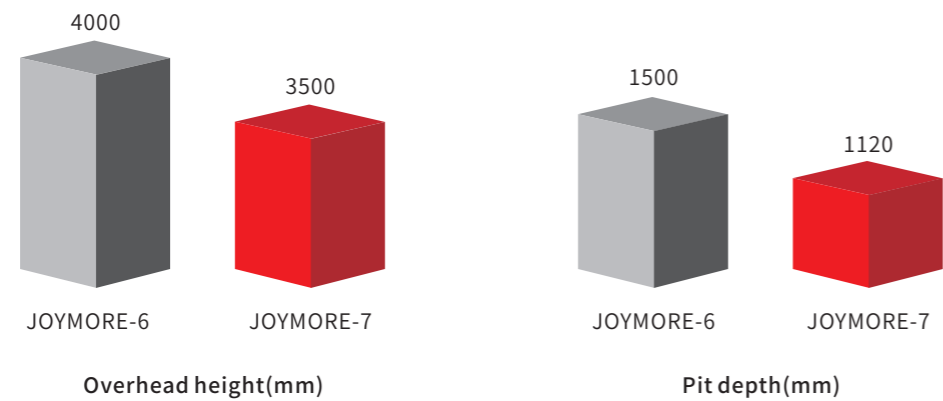



Safety Escort, Human Experience

Patent UCMP function to prevent accidental movement of car

Patent No.: ZL201320606488.3

Car accidental movement protection device prevents car from accidentally moving without command in door opening area to protect passengers safely.



CANBUS serial communication to improve elevator stability

Extensive application of CANBUS communication technology in aviation and automotive industries, comprehensively enhance the system response speed and stability, and control system efficiently and stably.

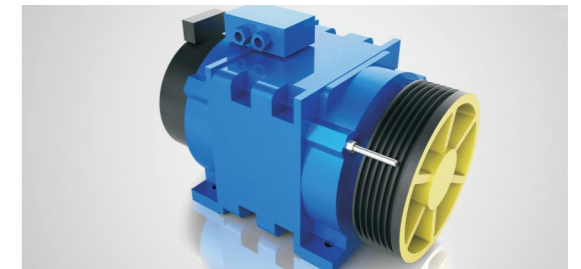

Traction rope anti-loose detection, provides better security guard

Patent No.: ZL201420470694.0

Traction rope anti-loose detection device detects whole process timely, when the traction rope is slack, elevator stops running immediately to ensure safe ride.

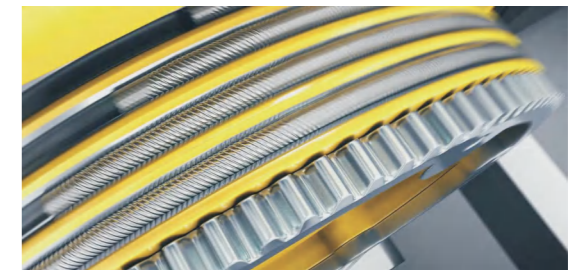

Intelligent maintenance, safe medical examination

Detect elevator operation and provides protection in whole process. Intelligent safety system accurately records fault and informs fault code to improve maintenance efficiency and bring convenience to maintenance staff.



Careful and Comfortable

Intelligent light curtain

Direct docking

Noise reduction device

Intelligent light curtain configuration to protect passengers safely on delivery

Adhering to the "people-oriented" design philosophy, barrier-free concept is subtly influenced by industrial details. JOYMORE-7 forms a dense infrared cross-light curtain at the entrance of elevator, which can respond sharply to people or objects entering its detection area to protect passengers boarding safely.

Direct docking technology for smooth and comfortable operation

Passengers walk out of car as on flat land, direct docking, accurate positioning, to ensure elevator stay in optimal operation at all times, creating a free and comfortable living space.

Noise reduction device, quiet and comfortable ride experience

Strictly selected materials, innovative technology, non-contact magnetic induction technology, eliminate collision noise of terminal station switches, achieve forced speed change without noise and vibration, noise reduction device to create quiet and comfortable ride.



Energy Efficient, Green Living



German TÜV energy efficiency certification, leading low carbon life

Germany TÜV energy-saving energy efficiency test and evaluation, obtained VDI 4707 PART1 highest level A-level energy-saving certification, achieved elevator energy-saving pioneer, leading low-carbon life.



EU electromagnetic compatibility EMC standard, safety and intimate protection

Electromagnetic compatibility means that electronic equipment does not cause electromagnetic interference to other equipment during operation. EU CE certification, meet EMC's electromagnetic compatibility and environmental protection standards, low radiation without electromagnetic pollution, offering passengers green security protection.



Intelligent control system saves more energy

IFE responds to green environmental protection requirement. When no one is taking the elevator, the intelligent control system can automatically switch the lighting and ventilation to standby mode to create a green-driven elevator.



Energy feedback system (Optional)

Energy feedback system can be customized to input electric energy from the motor into grid or to other electrical equipment to use, which can save more than 30% energy. Meanwhile, energy feedback system extends service lifespan of elevator other electrical equipments and can reduce temperature of machine room.



Environmentally friendly drive system, energy saving up to 45%

Innovatively uses permanent magnet synchronous traction machine to drive elevator to improve operation efficiency, low starting current, small volume and low noise. Compared with the worm gear driven elevator, energy saving is 40~45%, noise is reduced by 5~10dB(A).



Standard Configuration

Enjoy a different space experience while being comfortable and warm, clean, tidy and easy to maintain.



CAR75-06

COP: COP34-00 Hairline stainless steel / dark gray plexiglass / white dot matrix display

Ceiling: C60-00 Hairline stainless steel / LED ceiling light

Car wall: CW03-00 Hairline stainless steel

Car door: L01-00 Hairline stainless steel

Floor: F01-00 Wear-resistant PVC

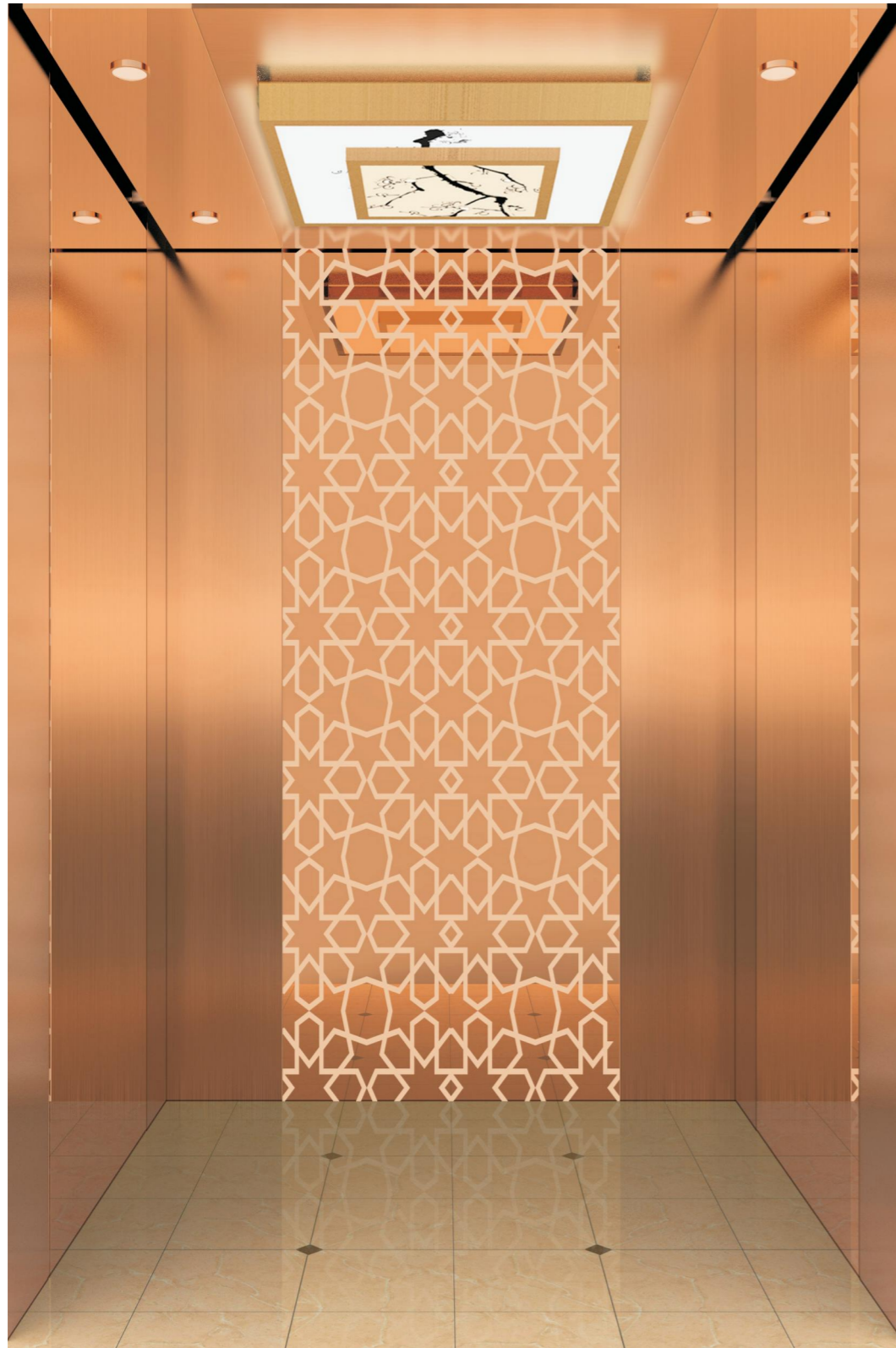

CAR90-06(Optional)

Ceiling: C61-05 Hairline stainless steel plated rose gold / mirror stainless steel plated rose gold / LED ceiling light / antique ceiling lamp
Car wall: CW04-08 Hairline stainless steel plated rose gold on both walls of side wall/ intermediate mirror stainless steel plated rose gold
 Hairline stainless steel plated rose gold on both walls of back side/ intermediate mirror stainless steel etched rose gold on both sides of the back wall
 Front wall hairline stainless steel plated rose gold
Car door: L01-09 Hairline stainless steel plated rose gold
Floor: F01-10 Wear-resistant PVC

Note: Antique ceiling lamps are seasonal and popular products. Specific styles are subject to popular styles in the current market.
 There is a slight difference between the physical objects and the effects. The final interpretation right belongs to our company.



CAR80-02(Optional)

Ceiling: C99-09 Hairline stainless steel / LED ceiling light / mirror stainless steel etching
Front wall: Hairline stainless steel
Side wall: CW01-05 Two-sided hairline stainless steel / intermediate mirror stainless steel etching
Rear wall: Two-sided hairline stainless steel / intermediate mirror stainless steel etching
Car door: L01-00 hairline stainless steel
Floor: F01-01 Wear-resistant PVC

Decoration Configuration

COP, Display, HOP (Standard +Optional Configuration)



COP34-00
(Standard configuration)
Panel: Hairline Stainless Steel
Display: White dot matrix



COP35-00
(Optional configuration)
Panel: Hairline Stainless Steel
Display: White segment code LCD

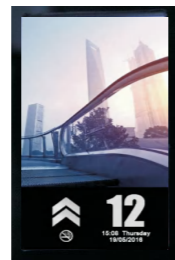

LCDP070 (Optional Configuration)
Picture machine LCD display
Display size: 7 inches (154*86mm)



HOP37-00
(Standard Configuration)
Panel: Hairline Stainless Steel
Dark grey plexiglass
Display: White dot matrix



HOP38-00
(Optional configuration)
Panel: Hairline Stainless Steel
Dark grey plexiglass
Display: White segment code LCD



HOP39-00 (Optional configuration)
Panel: Hairline stainless steel
Dark gray plexiglass
Display: White dot matrix

Ceiling(Standard +Optional Configuration)

Use the following ceiling style, hoistway overhead height should be $\geq 3700\text{mm}$

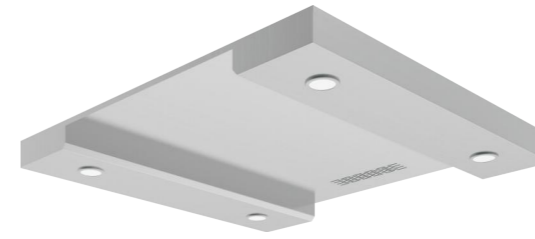

C22-00 Hairline stainless steel / LED ceiling light
Note: C22 ceiling is not suitable for deep car



C17-00 Hairline stainless steel / Acrylic light transmission column / PC light transmission board



C08-00 Hairline stainless steel/LED ceiling light / Translucent Acrylic Tubes

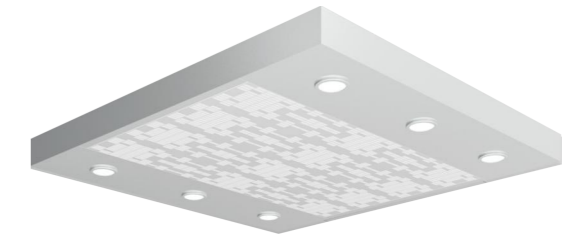

C99-09 Hairline stainless steel/LED ceiling light /mirror stainless steel etching



C16-00 Hairline stainless steel / PC light plate / LED ceiling light

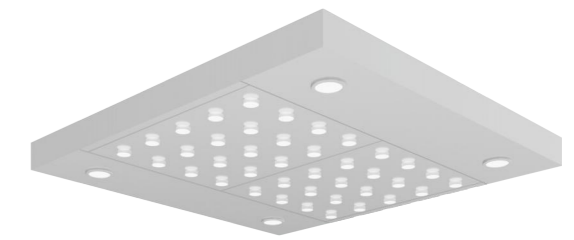

C21-00 Hairline stainless steel / Translucent Acrylic Tubes / LED ceiling light
Note: C21 ceiling is not suitable for deep car

PVC Floor (Standard +Optional Configuration)



F01-00(Standard)

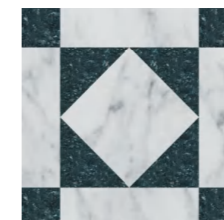

F01-03(Optional)



F01-04(Optional)



F01-05(Optional)

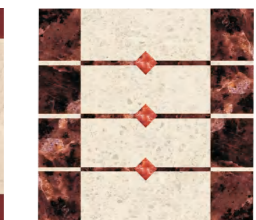

F01-07(Optional)

Handrail (Optional Configuration)

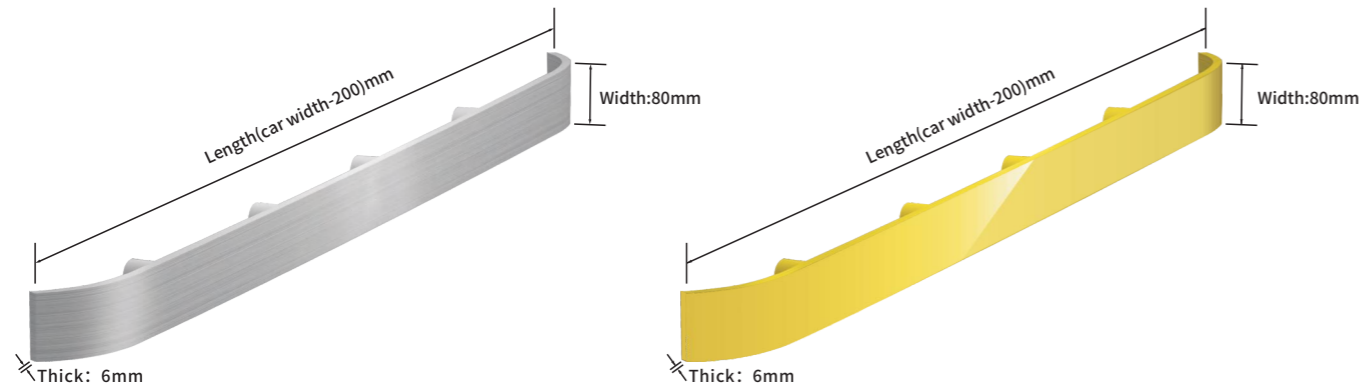

H01-00 (Flat elbow handrail) Hairline stainless steel
H01-01 (Flat elbow handrail) Mirror stainless steel

H01-02 (Flat elbow handrail) Titanium mirror stainless steel

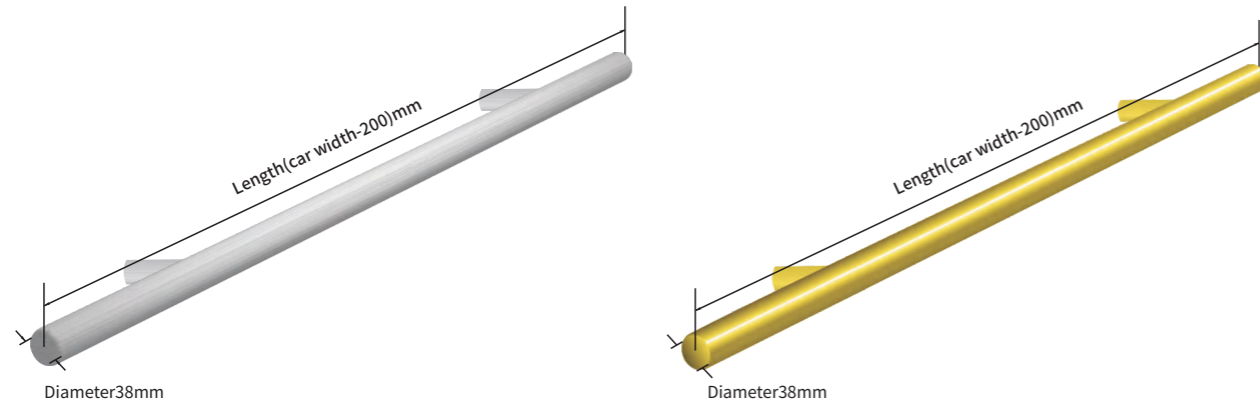

H05-00 (Cylindrical handrail) Hairline stainless steel
H05-01 (Cylindrical handrail) Mirror stainless steel

H05-02 (Cylindrical handrail) Titanium mirror stainless steel

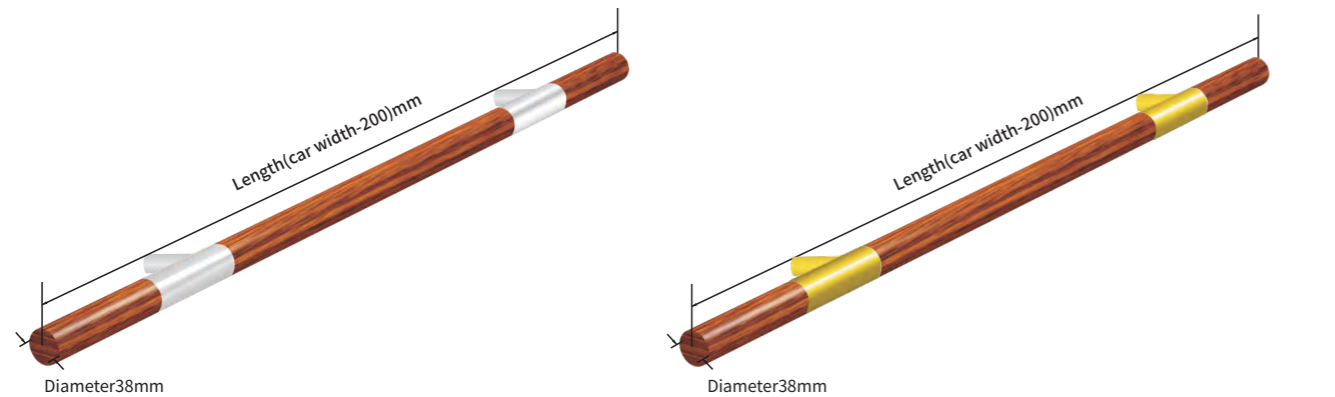

H06-00(Wooden cylindrical handrail)
 Black walnut wood cylinder+ Mirror stainless steel bracket

H06-01(Wooden cylindrical handrail)
 Black walnut wood cylinder + titanium mirror stainless steel bracket

Landing Door and Jamb (Standard+ Optional Configuration)



Landing door: **L01-00 (Standard)** Hairline stainless steel (first floor)
L01-05 (Standard) Steel plate sprayed matt grey(other floor)
 Jamb: **LDJ01-00(Standard)** Hairline stainless steel (first floor)
LDJ01-01(Standard) Steel plate sprayed matt grey (other floor)



Landing door: **L02-02 (Optional)** Mirror stainless steel etching
 Jamb: **LDJ01-00 (Standard)** Hairline stainless steel



Landing door: **L02-06 (Optional)** Mirror stainless steel etching
 Jamb: **LDJ01-00 (Standard)** Hairline stainless steel

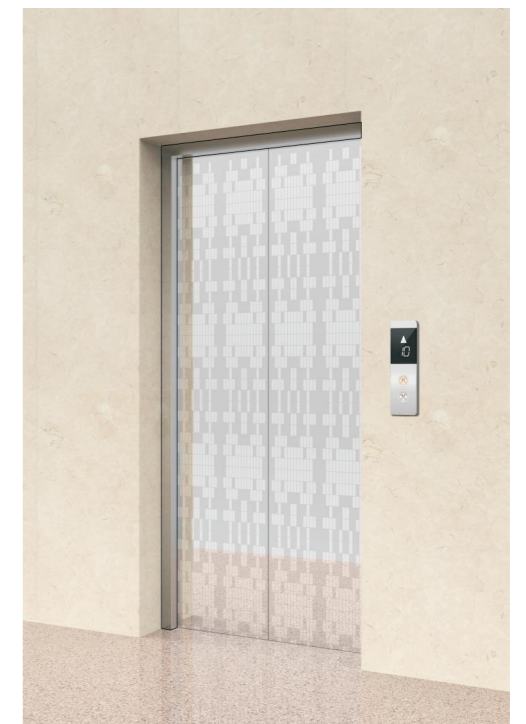

Landing door: **L02-08(Optional)** Mirror stainless steel etching
 Jamb: **LDJ01-00(Standard)** Hairline stainless steel

JOYMORE-7 Passenger Elevator

BASIC FUNCTION

Operation Function

01	Full Selective Collection	Collect at the calling signals to answer selectively based on the signal control system
02	Full Load By-pass	No response to the hall calling signal when the lift is at full load in automatic mode, but only answers the car calling signal
03	Car Call Reset	Double click the COP button to cancel the wrong command to achieve car call reset
04	Door Open / Close Button	Micro buttons on the cop to control the door open/close so that passengers could handle the open /close timing flexibly
05	Door Open /Close Button Light	Door open/close button light lights up to indicate the successful answer
06	Resume Operation in Power Supply	When the position signal is failed to retain or not sure about the elevator position after a power failure, the elevator would go to the end floor to re-position and be back to normal running
07	Automatic Home Landing	The elevator would be back to base floor to stand by under automatic condition if there is no calling command within the setting time
08	Anti-nuisance Car Call Protection	The computer detects the load and number of car calling registration then judges the command by logic. All signals will cancel if the command is not quite normal
09	Door Reopening by Landing Call	Push the HOP button same as the elevator going direction when the door is closing, then the door will reopen
10	Torque Compensation in Start	The system will calculate as per the load in elevator and optimize the torque compensation to give more comfort when the elevator starts
11	Direct Landing Technology	Micro-computer controller automatically calculates the optimum speed profile according to the target floor distance and directly lands without crawling

Safety Function

12	Safety Loop Protection	When the elevator falls, elevator microcomputer control system will report the fault code based open the preset fault code to bring convenience to maintenance staff
13	Absent or Mistaken Epsilon Phase Device	When the power supply is off phase or phase sequence is wrong, system safety circuit will be disconnected and the elevator will stop running
14	Overload Protection	When the car is loaded beyond the rated load, overloading buzzer will sound to alert. At this moment, the door is not closing and the elevators is not working
15	Safety Curtain with Multiple Light Beams	System forms dense infrared across the door. When a person or object enters the detection area, the system will response sharply in order to protect passengers from the risk of door
16	Door Reverse	The door is subjected to a reverse resistance exceeding the preset torque value when it is closing, the elevator will reopen

BASIC FUNCTION

Safety Function

17	Door Interlock Protection	When the landing door and car door are both in normally closed status, the elevator will operates normally only when the control system judges the elevator is normal
18	Landing Zone Guard	For safety reason, the car door cannot open in the non-leveling area
19	Downward Over Speed Protection	When the downward speed of elevator exceeds a specified speed, the governor will take action and the safety circuit will be cut off while safety gear brakes, then the car stops on the guide-rail
20	Upward Over Speed Protection	When the upward speed of elevator exceeds a specified speed, the governor will take action and the safety circuit will be cut off while the action machine brakes, then the car stops
21	Reversal Movement Guard	When the system detects the actual running direction is inconsistent with the specified direction, the car stops immediately and alarms
22	Brake Guard	Brake relay signals are being monitored in the entire process, when the brake relay finds the actual states is inconsistent with the specified command, the system will stop the elevator operating
23	Contractor Non-releasing Protection	No matter the elevator is running to the terminal station and the operating speed is not reduced to a preset value, the system will be forced to slow down to ensure the safe operation of elevator
24	Speed Limited Switching in Terminator	When the elevator passes over the terminal nation and the operating state, the system will output the contractor condition. Once, the contractor is in abnormal state, the system will stop the elevator operating
25	Buffer Safety Protection	When the elevator passes over the terminal floor for some reason, car buffer and counterweight buffer will star the protection and the safety circuit will be cut off in the meantime
26	Microcomputer self-check Protection	The system scans the input and output points of controller before the start of elevator. The elevator will stop starting if the data is abnormal
27	Anti-locked-rotor Feature of Motor	If the traction machine does not run due to mechanical jamming when the elevator is starting operating and it exceeds the preset timing, the system will stops the elevator operating
28	Fault Storage	The computer stores the accidental record of elevator. It can be supplied to elevator manufacturers and maintenance staff for statistical analysis
29	Star Closure Method	When the brake fails and leads to an unintended movement of elevator, the three-phase winding of the permanent magnetic synchronous motor will be in short circuit and turn to power generation state. It drives the elevator running at the speed of 0.1m/s and eliminates the risk of high-speed slip to ensure the safety of passengers
30	Hoisting Rope Anti-loose Detection	The hoisting rope is under real-time detection during the elevator operation and when single or multiple hoisting ropes are detected to be stack relaxation, the elevator stops immediately
31	Hoisting Rope Anti-loose Detection	The hoisting rope is under real-time detection during the elevator operation and when single or multiple hoisting ropes are detected to be stack relaxation, the elevator stops immediately
32	Brake Monitoring Device	Brake monitoring device detects if the left and right sides of the brake action are consistent or reliable If they are inconsistent or unreliable, the control system will automatically report to the brake fault detection , so that the motor stops running to prevent the traction machine brake failure
33	UCMP	When the elevator is stopping at the leveling floor and the landing door or the car door is not totally closed, the car is unintended moving t and leaves the lock open area, then the elevator is forced to stop if the UCMP dashboard detects danger signals so that it protects the passengers

JOYMORE-7 Passenger Elevator

BASIC FUNCTION

Special Operation

34	Attendant Operation	By opening the switch in COP, the elevator will be turned into the attendant operation state so the driver may manage the number of passengers in the car, hall call response and opening/closing doors
35	By-pass Switch	After entering the driver operation state, pressing by-pass button before the start, the elevator does not respond external call in the next course of operation, and goes straight to the floor with the registration by drivers operating instructions in the car
36	Buzzer	When the elevator is the drive operation state, buzzer will sound to alert the drives that someone is calling if it is registered by external call
37	Independent Service	The dedicated operation function, when the elevator no longer responds to the call signal outside the hall, but can only be manually controlled to open and close the door
38	Main Floor Setting	According to site requirements by setting the main station based on basic parameters, the elevator will return to the preset floor when it exceeds a specified timing without any operations
39	Firefighting Floor Settings	According to site requirements by setting fire man service floor based on the basic parameters, the elevator will land to the preset floor when inputting the fireman service signal
40	Inspection Operation	Pressing direction buttons on the junction box at car top to control the elevator to go forwards the direction selected or opening、closing buttons to control the operation of doors makes the maintenance faster and more convenient
41	Flexible Car Park Set	Clients can decide the elevator stops or not on a specified floor

Interface

42	LED Display Inside the Car	LED simply on the COP shows the information about floors and directions
43	Hall LED Display on the First Floor	Hall LED display shows the information about floors and directions
44	Floor Mark Flexible Set	The type of words special floors can be customized regarding to the requirements
45	Arrival Chime	Arrival chime will sound when the elevator is arriving at a certain floor
46	Braille button	Braille buttons are used in the control panel and buzzer of the car for the convenience of the blind and the passengers with poor eyesight

Emergency Function

47	Car Alarm	For passengers to notify outside world in time by connecting alarm button in the car under special circumstances
48	Emergency Lighting	Emergency lighting devices installed in car will be used when power failure occurs
49	Inside Call Device	Realize five-way communication among car, bottom pit, car roof, engine room and monitoring center. Customers provide cable from the monitoring center to the first floor of the elevator Specification: 4x0.75mm ² (for distances less than 1800m)

BASIC FUNCTION

Emergency Function

50	Fire Emergency Landing	Elevator will cancel all calling signals and go straight to the fire man service floor after receiving the fire signal. It will also keep the door opening and wait for the operation of fire man. It will return to normal use when the fire signal is canceled
51	Fire Emergency Landing Feedback	The system will give a signal to the management center to indicate the elevator has received the fire signal and is waiting for the operation of firemen after the elevator receiving the fire signal and being back to the fire man service floor
52	Emergency Rescue	When the safety gear, oil buffer ,upper limit switch, lower limit switch and governor take action, operating the emergency rescue function in the control panel makes the elevator run slowly in order to swiftly save people

Energy Saving Function

53	Parking Service	The parking stop switch, when the key switch is set on the designated floor, the elevator will return to the lock landing after answering all the instructions, and close the door to enter the energy-saving state
54	Energy Standby	Under the circumstance without any operation instructions, the elevator will enter automatic turn on/off mode within the preset timing and closing door, turning off the lights and fans inside the car

OPTIONAL FUNCTION

OPTIONAL FUNCTION

01	Voice Announcement	Voice announcement will sound when the elevator arriving at station
02	Auto Rescue Device	When the elevator suddenly stop during normal operation, the device immediately work and drive elevator slowly operate to the nearest floor, then elevator open door to rescue passenger
03	Power Regeneration Device	Elevators' reciprocating lifting and repeated braking respectively result in an elevator potential energy and kinetic energy released. When using power regeneration device, the release or potential energy and kinetic energy from elevator are converted to electrical energy in phase with the same frequency, then they feedback to the grid so as to achieve energy-saving purpose
04	Multiple Operation	When two elevators are using together, achieving co-ordination of hall call instructions to improve operational efficiency via serial communication to transfer data
05	Group Control Operation	Group control system is capable of 3 to 8 elevators for centralized control, so the elevator group can automatically select the most appropriate response, to avoid repeating the stops of elevator and to shorten the waiting time of passengers, improving operational efficiency, saving energy
06	Monitoring system	A microcomputer intelligent management system that can comprehensively monitor the elevator in community and provide the data to building functional management
07	IC Card Management	passengers can only call the elevator by swiping the card (authorized by the elevator owner)
08	Sub-COP	It is convenient for passengers to choose floor in the cabin

JOYMORE-7 Technical Specification

NO.	Specification	450			630			800			1050		
01	Capacity(kg)	450			630			800			1050		
02	Speed(m/s)	1.0	1.6	1.75	1.0	1.6	1.75	1.0	1.6	1.75	1.0	1.6	1.75
03	Operation System	Full collective selection operation											
04	Driving System	VVVF Driving											
05	Door Operator System	VVVF Door Control											
06	Traction machine	PM/Gearless											
07	Control System	CTRL80											
08	Communication	Serial Communication											
09	Central Opening Width	Car Size(mm) (width*depth*height)	unsuitable	1100*1400*2200			1350*1400*2200			1400*1600*2200			
	Car	Opening Size(mm) (width*height)	unsuitable	800*2100			800*2100			900*2100			
		Shaft Size(mm) (width*depth)	unsuitable	1770*1800			1920*1800			2000*2000			
10	Central Opening Deep Car	Car Size(mm) (width*depth*height)	unsuitable	unsuitable	unsuitable	1100*2100*2200							
	Car	Opening Size(mm) (width*height)	unsuitable	unsuitable	unsuitable	800*2100							
		Shaft Size(mm) (width*depth)	unsuitable	unsuitable	unsuitable	1800*2500							
11	Side Opening	Car Size(mm) (width*depth*height)	1000*1200*2200	1100*1400*2200			1350*1400*2200			1100*2100*2200			
	Car	Opening Size(mm) (width*height)	800*2100	800*2100			900*2100			900*2100			
		Shaft Size(mm) (width*depth)	1570*1600	1670*1800			1920*1800			1700*2500			
12	Travel Height(m)	≤45	≤75	≤45	≤75	≤45	≤75	≤45	≤75	≤45	≤75		
13	Motor Position	Inside the shaft											
14	Overhead Height(mm)	3500	3700	3500	3700	3500	3700	3500	3700	3500	3700		
15	Pit Depth(mm)	1120	1230	1120	1230	1120	1230	1120	1230	1120	1230		
16	Power Supply & Min.Wiring Requirement	380V,50Hz, 3-phase 5-wire,zero wire and ground separated, Grounding resistance≤4Ω, see requirements on hoistway plan drawing											
		3*6mm ² +2*6mm ²	3*10mm ² +2*6mm ²	3*6mm ² +2*6mm ²	3*10mm ² +2*6mm ²	3*6mm ² +2*6mm ²	3*10mm ² +2*6mm ²	3*6mm ² +2*6mm ²	3*10mm ² +2*6mm ²	3*6mm ² +2*6mm ²	3*10mm ² +2*6mm ²		

Note: 1.Deep car is used for specified application, such as for stretcher delivery in evacuation occasions.
 2.Car height is 2200mm, Refers to the height of the car floor to the car roof. Optional rest of the ceiling to be increased accordingly tall top.
 3.If dual opening, cover plate needed in the pit.

center opening hoistway plan

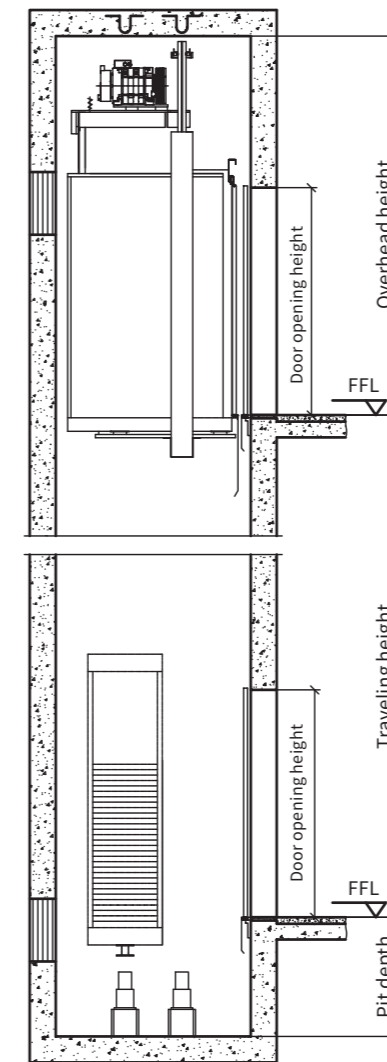

Side opening hoistway plan

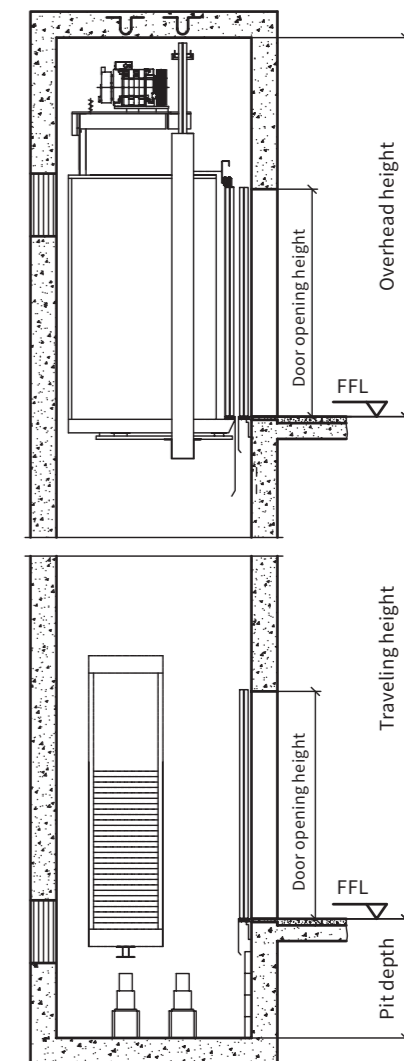

center opening hoistway layout profile

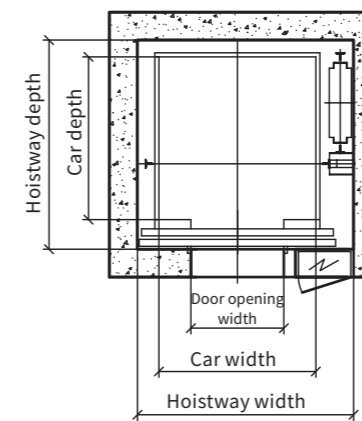

Side opening hoistway layout profile

